

RL-851-S-94

Recessed Mount LED Channel

Description

The RL-851-S-94 is recessed mount LED channel. It includes a channel, lens, and end caps. Available in 94" sections.

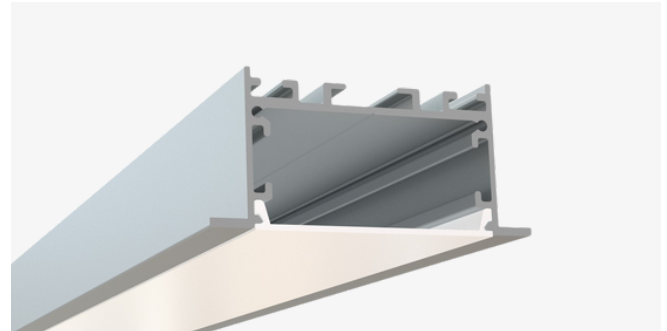

Features

- Compatible with all of EnoLED's LED Tapes
- Hotspot-free
- Aluminium Finish
- Available in 94" sections
- Field Cuttable
- Includes a channel, lens, end caps, and mounting clips
- Max tape width: 1.57" (40.00mm)

Dimensions

RL-851-S-94

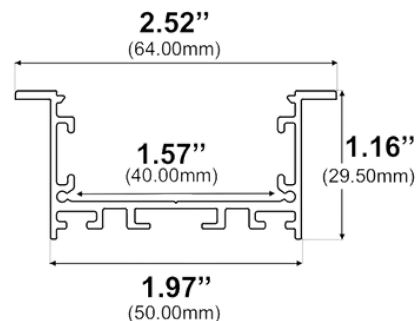

Width (outside): 2.52" (64.00mm)

Width (inside): 1.57" (40.00mm)

Height: 1.16" (29.50mm)

Length: 0.96" (2.44mm)

Ordering Information

Ordering Code	Description
RL-851-S-94	94" Channel kit - Includes 1 channel, 1 cover lens, 2 end caps, 3 mounting clips
RL-851-S-94-CL	94" Cover lens
RL-851-S-94-EC-P2	End caps - 2 pair pack includes 2 open, 2 closed
RL-851-S-94-EC-P10	End caps - 10 pair pack includes 10 open, 10 closed
RL-851-S-94-MS	Mounting spring kit - Includes 2 mounting springs (sold separately)