

# CATALOG 2024

Welcome to EnoLED, a leading manufacturer of Cutting Edge Lighting Technologies



## OrroBasic

24VDC, 16.4ft Performance & Value LED Tape Light



### SPECIFICATIONS:

- **Input voltage:** 24VDC
- **Power:** 2.2W/ft
- **Lumens:** 211lm/ft
- **CRI:** 90+
- **Environment:** IP20
- **Dimensions (W x H x L):** 0.31" x 0.055" x 196.85"
- **Dimming options:** Incandescent, CLF, LED, MLV, ELV, 0-10V, Wireless
- **Adhesive:** Red 3M
- **Wire:** 36" lead wire & connectors included

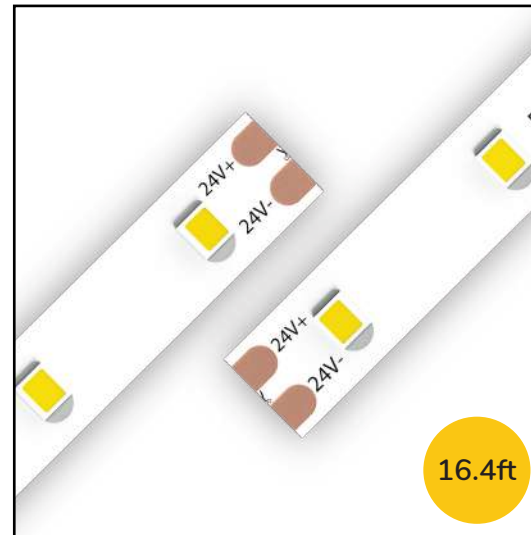

### PART NUMBERS:

- OrroBasic-27-16
- OrroBasic-30-16
- OrroBasic-35-16
- OrroBasic-40-16
- OrroBasic-50-16

### Available Color Temperatures:

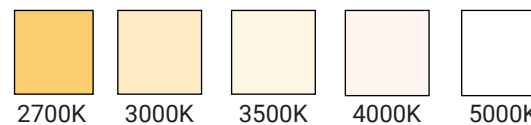



## OrroPlus

24VDC, 16.4ft Performance & Value LED Tape Light

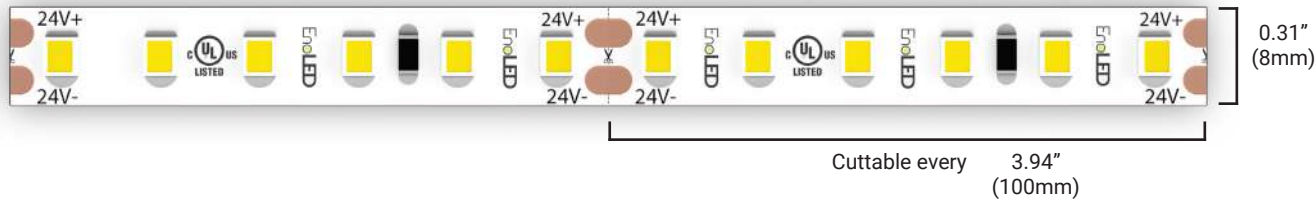

### SPECIFICATIONS:

- **Input voltage:** 24VDC
- **Power:** 4.4W/ft
- **Lumens:** 422lm/ft
- **CRI:** 90+
- **Environment:** IP20
- **Dimensions (W x H x L):** 0.31" x 0.055" x 196.85"
- **Dimming options:** Incandescent, CLF, LED, MLV, ELV, 0-10V, Wireless
- **Adhesive:** Red 3M
- **Wire:** 36" lead wire & connectors included

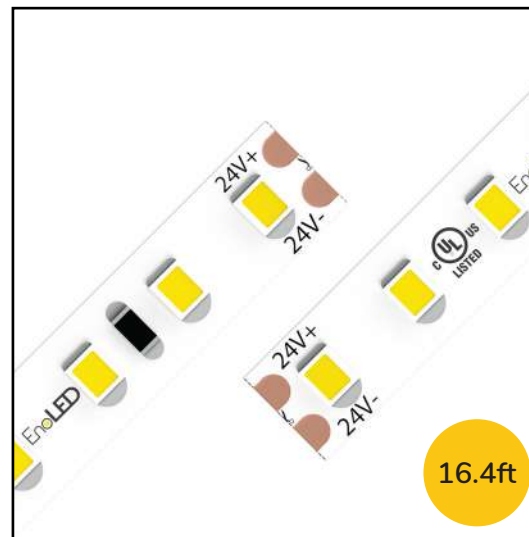

### PART NUMBERS:

- OrroPlus-27-16
- OrroPlus-30-16
- OrroPlus-35-16
- OrroPlus-40-16
- OrroPlus-50-16

### Available Color Temperatures:

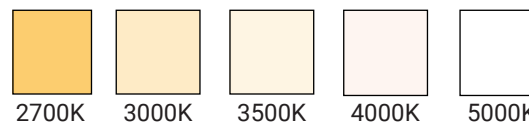

## UniBasic COB

24VDC Performance and Value COB LED Tape Light

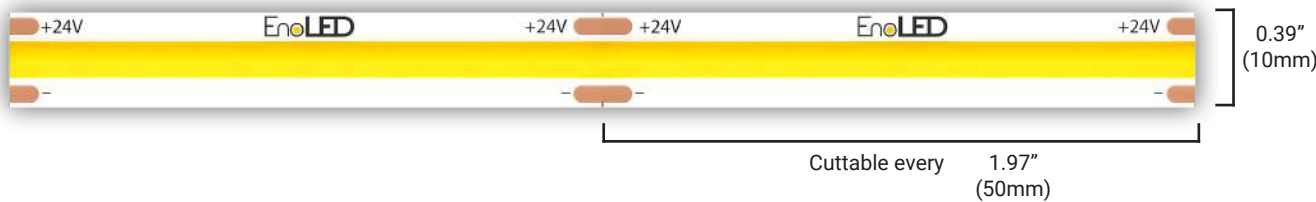

### SPECIFICATIONS:

- **Input voltage:** 24VDC
- **Power:** 3W/ft
- **Lumens:** 293lm/ft - 347lm/ft
- **CRI:** 90+
- **Environment:** IP20
- **Dimensions (W x H x L):** 0.39" x 0.05" x 196.85"
- **Dimming options:** Incandescent, CLF, LED, MLV, ELV, 0-10V, Wireless
- **Adhesive:** 3M
- **Wire:** 36" lead wire & connectors included

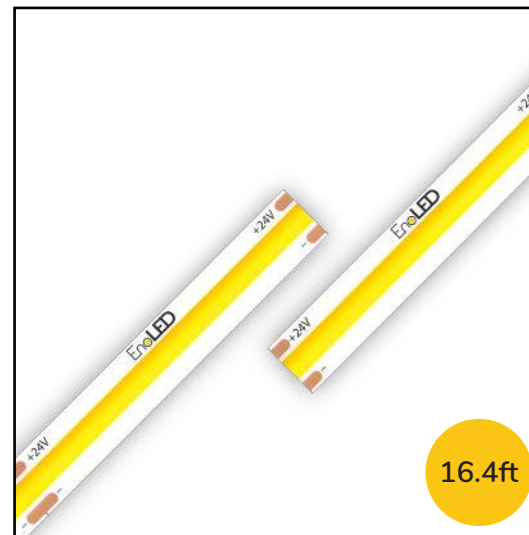

### PART NUMBERS:

UniBasic-27-16  
UniBasic-30-16  
UniBasic-35-16  
UniBasic-40-16  
UniBasic-50-16

### Available Color Temperatures:

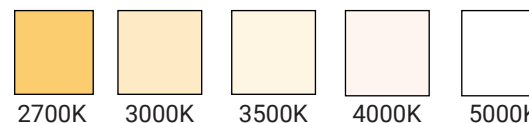

## UniPlus COB

24VDC Performance and Value COB LED Tape Light

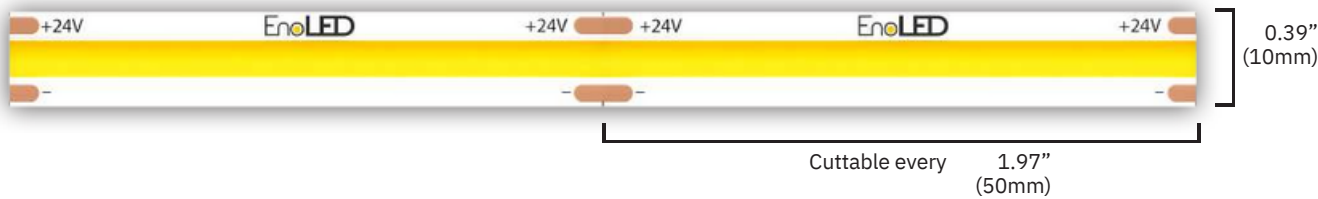

### SPECIFICATIONS:

- **Input voltage:** 24VDC
- **Power:** 4.6W/ft
- **Lumens:** 432lm/ft - 511lm/ft
- **CRI:** 90+
- **Environment:** IP20
- **Dimensions (W x H x L):** 0.39" x 0.05" x 196.85"
- **Dimming options:** Incandescent, CLF, LED, MLV, ELV, 0-10V, Wireless
- **Adhesive:** 3M
- **Wire:** 36" lead wire & connectors included

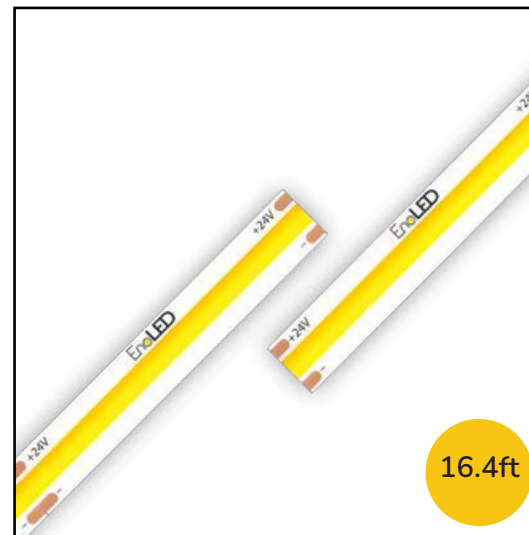

### PART NUMBERS:

- UniPlus-27-16
- UniPlus-30-16
- UniPlus-35-16
- UniPlus-40-16
- UniPlus-50-16

### Available Color Temperatures:

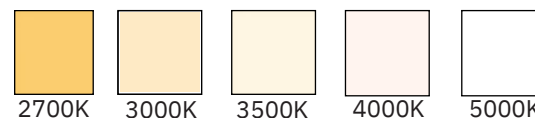



## DynamicPlus

24VDC Flexible LED Strip Multi-Color RGB+TW

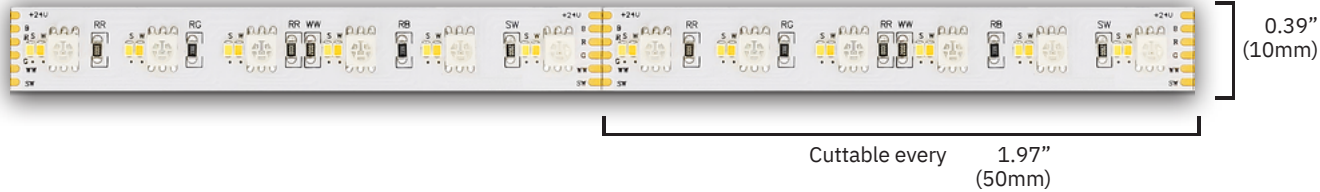

### SPECIFICATIONS:

- **Input voltage:** 24VDC
- **Power:** 7.92W/ft
- **Lumens:** 453lm/ft
- **CRI:** 90+
- **Environment:** IP20
- **Dimensions (W x H x L):**  
0.39" x 0.05" x 196.85"
- **Dimming options:** ---
- **Adhesive:** 3M
- **Wire:** 36" lead wire & connectors included



### PART NUMBER:

DynamicPlus-16

Available Color Temperatures:

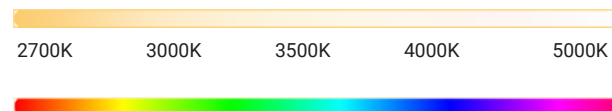

## 4" / 6" Downlight + Wall Switch Kit

Ultra-Thin RGB+CCT Wireless Downlight

### SPECIFICATIONS:

- **Control options:** RGBCW Wall Switch / App / Voice Control
- **Size:** 4 Inch / 6 Inch
- **Power:** 11.3W / 14.6W
- **CCT:** RGB+CCT(2700K-6000K)
- **Input voltage:** 120VAC
- **Lumens:** 920lm/ft / 1360lm/ft
- **CRI:** 90+
- **Mounting:** Recessed mount
- **Dimming:** 0-100%
- **Beam angle:** 110°
- **Operating temp:** -20°F -104°F

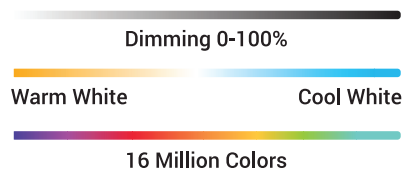
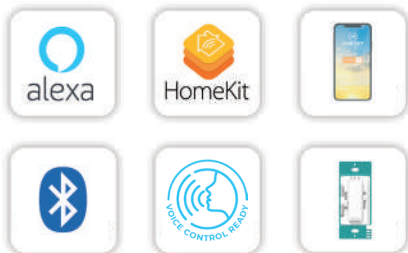

MADE IN ISRAEL



Download the App





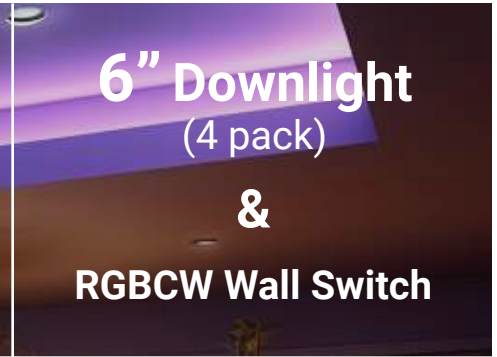
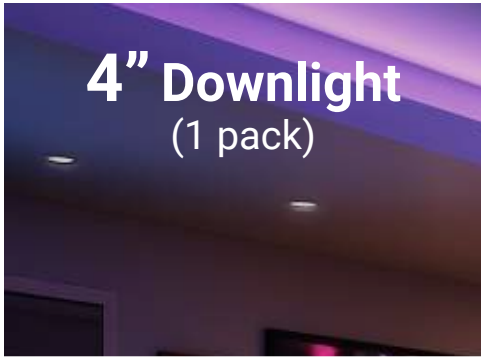

**PART NUMBER:**  
WSD-RGBCW-4

**PART NUMBER:**  
4PK-WSD-RGBCW-4

**PART NUMBER:**  
WSD-RGBCW-6

**PART NUMBER:**  
4PK-WSD-RGBCW-6



## XRD Series

12/24VDC Super Compact Phase Cut Dimmable, Class 2, J-Box LED Drivers



Class 2



### SPECIFICATIONS:

- **Input voltage:** 120VAC
- **Output voltage:** 12 / 24VDC
- **Max load:** 40W, 60W, 75W, 96W
- **Dimmable:** CLF / LED / MLV / ELV
- **Minimum dimming:** 0.1%
- **Dimensions:** 6.20"×1.85"×1.35" (L\*W\*H)
- **Environmental:** Dry & Damp Location
- **Certification:** UL, Class 2

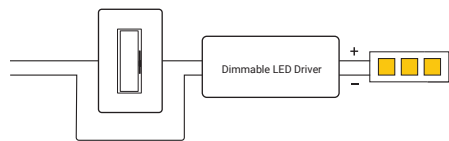
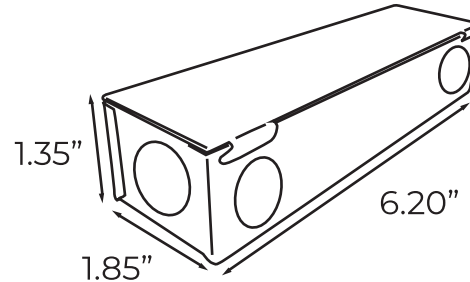

### PART NUMBERS:

- XRD-96W-24VDC
- XRD-75W-24VDC
- XRD-60W-24VDC
- XRD-40W-24VDC
- XRD-60W-12VDC
- XRD-40W-12VDC



Built-In JBox

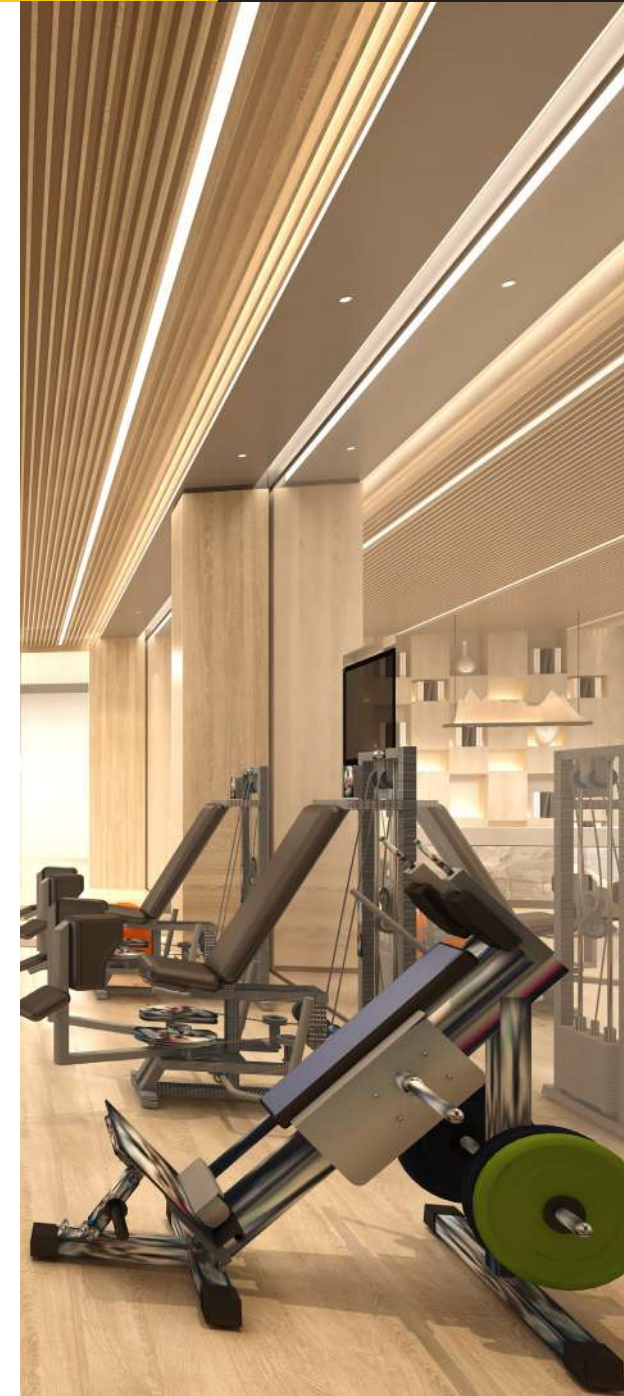

## MRD Series

Super Compact Phase Cut Dimmable,  
Class 2, LED Drivers

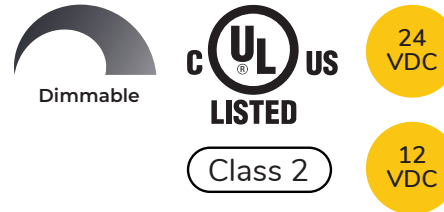

### SPECIFICATIONS:

- **Input voltage:** 120VAC
- **Output voltage:** 12 / 24VDC
- **Max load:** 40W, 60W, 75W, 96W
- **Dimmable:** CLF / LED / MLV / ELV
- **Minimum dimming:** 0.1%
- **Dimensions:** 3.31"×1.57"×0.98" (L\*W\*H)
- **Environmental:** Dry & Damp Location
- **Certification:** UL

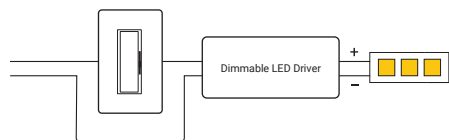
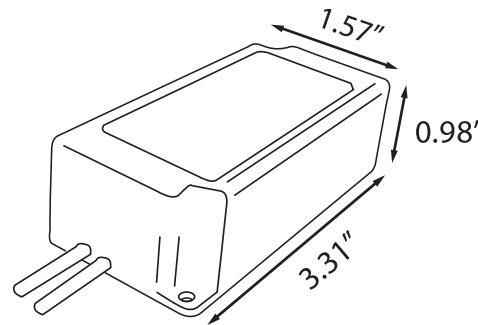

### PART NUMBERS:

- MRD-96W-24VDC
- MRD-75W-24VDC
- MRD-60W-24VDC
- MRD-40W-24VDC
- MRD-60W-12VDC
- MRD-40W-12VDC





## NanoDrive

0-10V Dimmable Class 2 J-Box LED Drivers

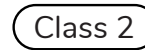

### SPECIFICATIONS:

- **Input voltage:** 120-277VAC
- **Output voltage:** 24VDC
- **Max load:** 96W, 60W, 40W
- **Dimmable:** 0-10V
- **Minimum dimming:** 1%
- **Dimensions:** 1.97" x 1.45" x 8.77"
- **Environmental:** Dry & Wet Location
- **Certification:** ETL, CE, FCC

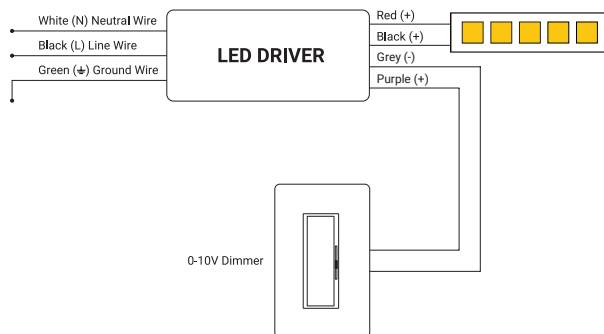
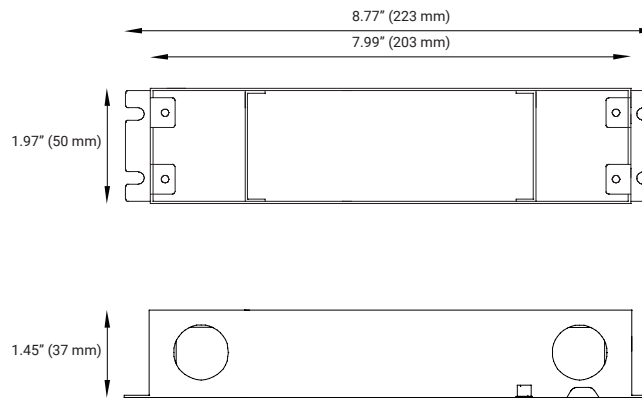

### PART NUMBERS:

- NANO-96W-24VDC
- NANO-60W-24VDC
- NANO-40W-24VDC



## ELD Series

Ultra Slim IP67 Plug In LED Drivers

### SPECIFICATIONS:

- **Input voltage:** 120VAC
- **Output voltage:** 24VDC
- **Max load:** 60W, 100W, 150W, 200W
- **Environmental:** IP67 Dry, Damp Location & Wet Locations
- **Certification:** UL

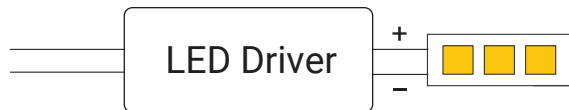

### PART NUMBERS:

- ELD-60W-24VDC-UL
- ELD-100W-24VDC-UL
- ELD-150W-24VDC-UL
- ELD-200W-24VDC-UL





## XLG Series

Super Compact IP67 LED Drivers



### SPECIFICATIONS:

**Input voltage:** 120-277VAC

**Output voltage:** 24VDC

**Max load:** 100W (class 2), 150W, 200W

**Environmental:** IP67 Dry, Damp Location & Wet Locations

**Certification:** UL

### DIMENSIONS:

**100W:** 5.51" x 2.48" x 1.25"

**150W:** 7.08" x 2.48" x 1.39"

**200W:** 7.83" x 2.48" x 1.39"



### PART NUMBERS:

XLG-100W-24VDC-UL

XLG-150W-24VDC-UL

XLG-200W-24VDC-UL



# CATALOG 2024



216-727-3618



customer@enoled.com



www.EnoLED.com