

## EnoSync Series Smart LED Controller

P/N: EnoSync-Hub5

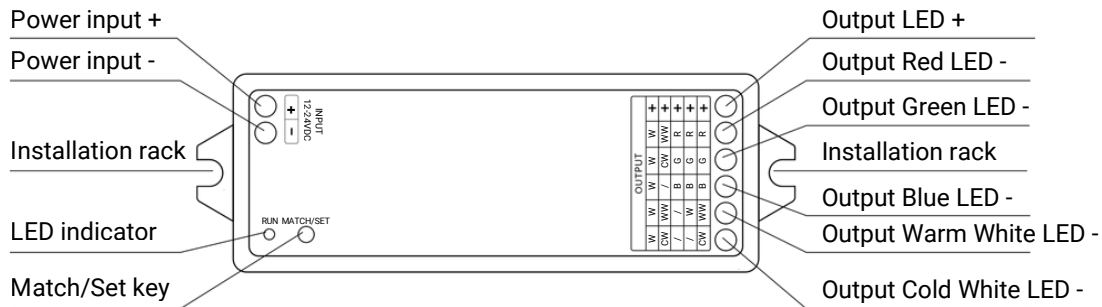

### User Interface



### System Wiring

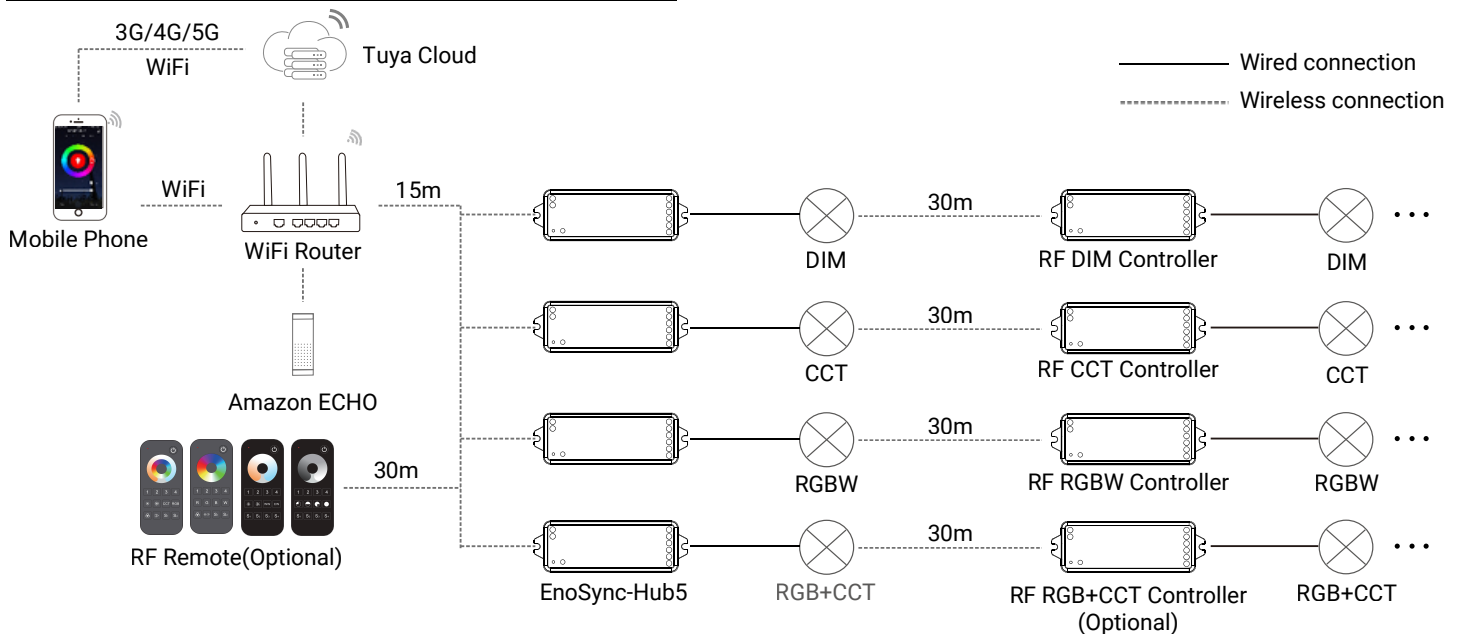

Note:

1. The above distance is measured in spacious (no obstacle) environment, Please refer to the actual test distance before installation.
2. Please check if the WiFi router net in 2.4G band, the 5G band is not available, and do not hide your router network.
3. Please keep the distance between EnoSync Series Smart LED Controller devices and router close, and check the WiFi signals.

### Mechanical Specifications

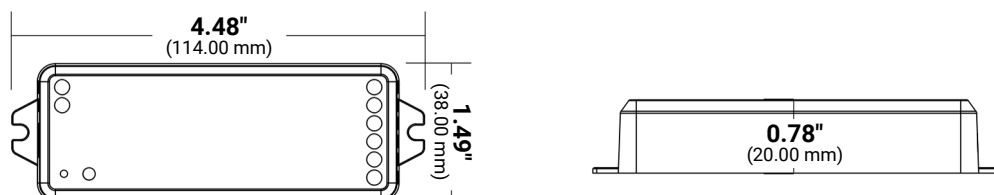

## EnoSync Series Smart LED Controller

P/N: EnoSync-Hub5



### Wiring Diagrams

#### For RGB+CCT

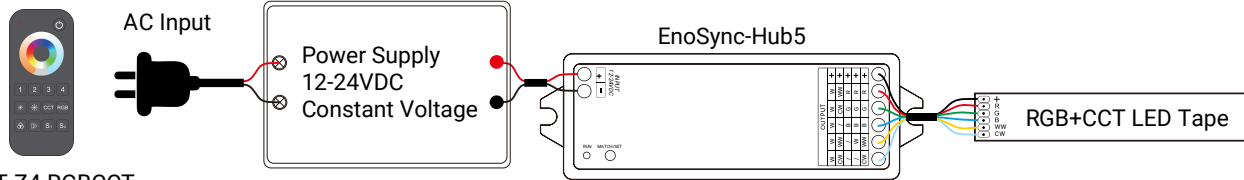

ES-RT-Z4-RGBCCT

Press and hold match/set key for 16s, until the RUN LED indicator turn blue, then release, the controller will become RGB+CCT type, then do smart config by Tuya smart APP, or short press match key to match with RGB+CCT RF remote.

#### For RGBW

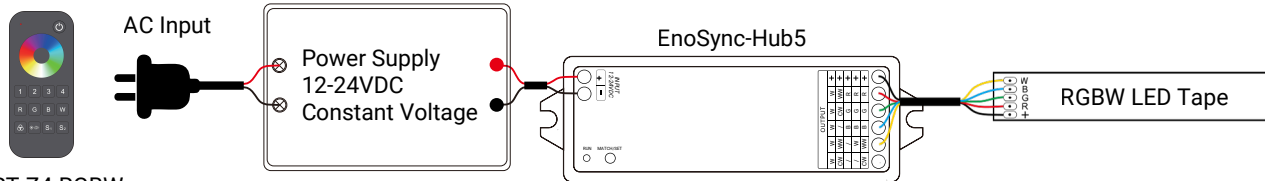

ES-RT-Z4-RGBW

Press and hold match/set key for 14s, until the RUN LED indicator turn green, then release, the controller will become RGBW type, then do smart config by Tuya smart APP, or short press match key to match with RGBW RF remote.

#### For CCT

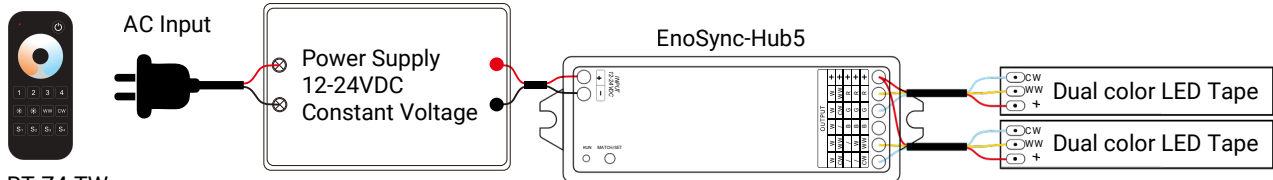

ES-RT-Z4-TW

Press and hold match/set key for 10s, until the RUN LED indicator turn yellow, then release, the controller will become TW type, then do smart config by Tuya smart APP, or short press match key to match with TW RF remote.

#### For Single Color

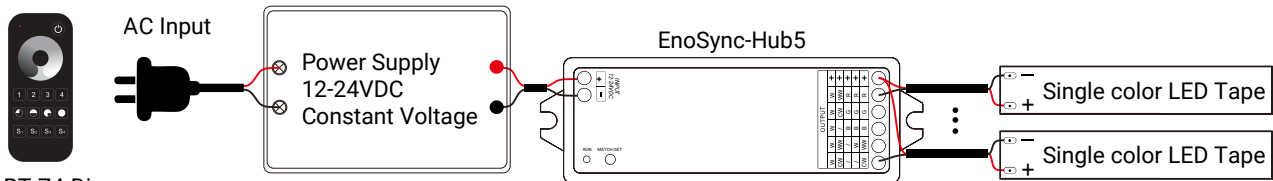

ES-RT-Z4-Dim

Press and hold match/set key for 8s, until the RUN LED indicator turn white, then release, the controller will become DIM type, then do smart config by Tuya smart APP, or short press match key to match with dimming RF remote.

**Note:**

1. Press and hold Match/Set key for 2s, switch 5 kinds light type in sequence.
2. For RGB+CCT or TW light type, continuous power on and off will change 3 levels color temperature (WW, NW and CW) in sequence.
3. Switch off the power, then switch on power, repeat again.  
Immediately short press match key 3 times, the light on/off time will change between 3s and 0.5s.

## EnoSync Series Smart LED Controller

P/N: EnoSync-Hub5



### Match Remote Control

Choose how to pair or remove the device. Two options are available.

#### Match Key Method



**Step 1:**

Short press the Match/Set button.

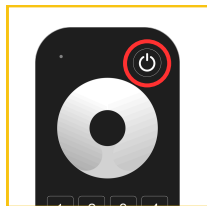

**Step 2:**

Single zone remote:  
Immediately press the **ON/OFF key**.

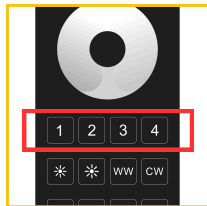

Multiple zone remote:  
Immediately press the **ZONE key**

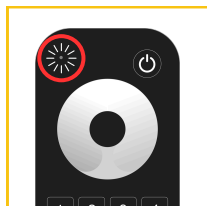

**Step 3:**

The LED indicator will flash quickly several times, confirming successful pairing.

#### Remove Remote Control:



**Step 1:**

Press and hold the **MATCH key for 20s** to delete all matched remotes.

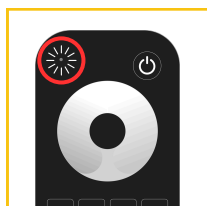

**Step 2:**

The LED indicator will flash quickly several times, confirming the remote was successfully removed.

#### Power Restart Method

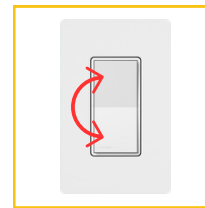

**Step 1:**

Switch the power off then on again.

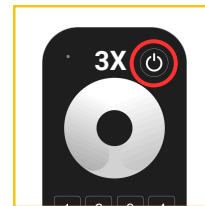

**Step 2:**

Immediately short press the **ON/OFF key 3 times** on the remote.

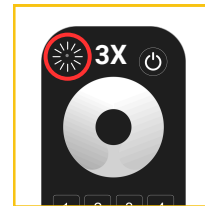

**Step 3:**

The LED indicator will flash quickly several times, confirming successful pairing.

#### Remove Remote Control:

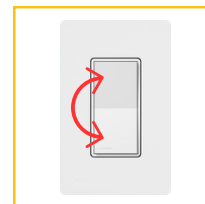

**Step 1:**

Switch the power off then on again.

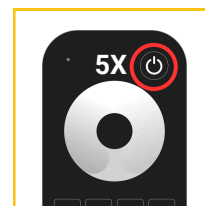

**Step 2:**

Immediately short press the **ON/OFF key 5 times** on the remote.

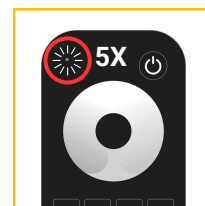

**Step 3:**

The LED indicator will flash quickly 5 times, confirming the remote was successfully removed.

# EnoSync Series

## Smart LED Controller

P/N: EnoSync-Hub5



### Tuya Smart APP Network Connection

- **Download and open APP**

Search for "Tuya Smart/Smart Life APP" in the app store, or scan the QR code on the right to download the APP. Register and login after installation.

- **APP Pairing Network**

Push twice Match/Set key fastly, or when press and hold Match/Set key for 8-16s to set 5 kinds light type:

Clear previous network connection, enter WiFi config mode, the LED indicator flash fastly, the output LED will flash 10 times.

Press and hold Match/Set key for 2s:

Switch 5 kinds light type in sequence, notice this operation does not automatically clear previous network connection.

Press and hold Match/Set key for 5s:

Clear previous network connection, enter WiFi config mode, the LED indicator flash fastly.

Repeat power on and off for 5 consecutive times, also clear previous network connection, enter WiFi config mode, the output LED will flash 10 times.

If Tuya Smart APP network connection succeed, the RUN LED indicator will stop flash, and turn corresponding light type color (White: DIM, Yellow: TW, Green: RGBW, Blue: RGB+CCT). and in Tuya Smart APP, you can find RGB+CCT device (or other DIM, TW, or RGBW).

When controlling the light with Tuya Smart/Smart Life APP, if the network connection is poor, you can control the light with Bluetooth connection within the Bluetooth control range.

Note: The light can not be directly controlled by Bluetooth without WiFi configuration.

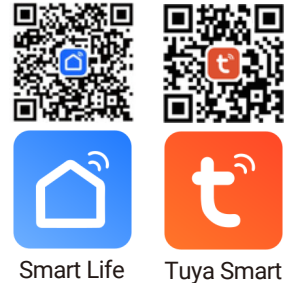

## EnoSync Series Smart LED Controller

P/N: EnoSync-Hub5



### Tuya Smart APP Interface

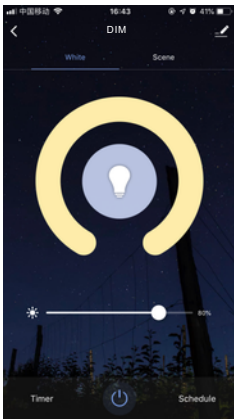

#### White interface

For DIM type:  
Touch brightness slide to adjust brightness.

For RGB type:  
Touch brightness slide, get RGB mixed white firstly, then to adjust white brightness.

For RGBW type:  
Touch brightness slide, adjust white channel brightness.

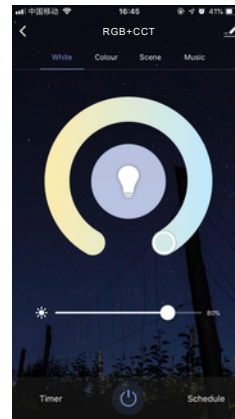

#### Color temperature interface

For CCT type: Touch color wheel to adjust color temperature. Touch brightness slide to adjust brightness.

For RGB+CCT type: Touch color wheel to adjust color temperature, RGB will turn off automatically. Touch brightness slide to adjust white brightness.

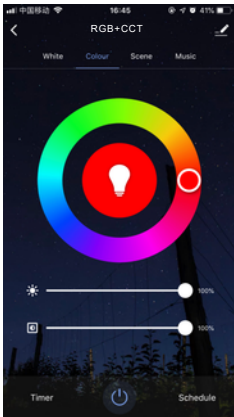

#### Colour interface

For RGB or RGBW type:  
Touch color wheel to adjust static RGB color. Touch brightness slide to adjust color brightness. Touch saturation slide to adjust color saturation, namely gradient from the current color to white (RGB mixed).

For RGB+CCT type:  
Touch color wheel to adjust static RGB color, WW/CW will turn off automatically. Touch brightness slide to adjust color brightness. Touch saturation slide to adjust color saturation, namely gradient from the current color to white (RGB mixed).

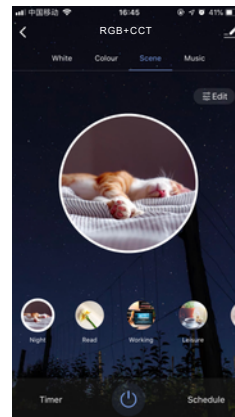

#### Scene interface

The 1-4 scene is static color for all light type. The inner color of these scene can be editable.

The 5-8 scene is dynamic mode for RGBW, RGB+CCT type, such as green fade in and fade out, RGB jump, 6 color jump, 6 color smooth.

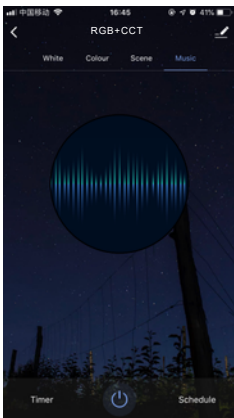

#### Music, Timer, Schedule

The music play can use smart phone music player or micro-phone as music signal input.

The Timer key can turn on or turn off light in the next 24 hours.

The Schedule key can add multiple timers to turn on or turn off light according to different time periods.

## EnoSync Series Smart LED Controller

P/N: EnoSync-Hub5



### Dynamic Mode List

For RGBW:

No.	Name
1	RGB jump
2	RGB smooth
3	6 color jump
4	6 color smooth
5	Yellow cyan purple smooth
6	RGB fade in and out
7	Red fade in and out
8	Green fade in and out
9	Blue fade in and out
10	White fade in and out

For RGB+CCT:

No.	Name
1	RGB jump
2	RGB smooth
3	6 color jump
4	6 color smooth
5	Color temperature smooth
6	RGB fade in and out
7	Red fade in and out
8	Green fade in and out
9	Blue fade in and out
10	White fade in and out

### Statement

**FCC ID Statement:**

Mobile

RF Exposure Information

This equipment complies with FCC radiation exposure limits set forth for an uncontrolled environment.

This equipment should be installed and operated with minimum distance 20cm between the radiator and your body.

## EnoSync Series Smart LED Controller

P/N: EnoSync-Hub5



### Features

- Smart LED Controller  
Supports RGBW, RGB+CCT, CCT, RGB, and single-color LED strips.
- Tuya Smart Life App  
Full control of color, CCT, brightness, scenes, timers, and music-sync.
- RF Remote Option  
One remote can control multiple controllers, and each controller can pair with multiple remotes.
- Voice Control  
Compatible with Amazon Alexa, Google Assistant, Tmall Genie, and Xiaodu.
- 12/24V, up to 360W load.
- Optional Soft On/Off  
Selectable 3-second fade-in/fade-out.



### Technical Parameters

#### Input and Output

Input Voltage:	12-24VDC
Input Current:	15A
Output Voltage:	5 x (12-24)VDC
Output Current:	5CH,3A/CH
Output Power:	5 x (36-72)W
Output Type:	Constant voltage

#### Environment

Operation temperature:	-30°C ~ +55°C/-22°F ~ +131°F
------------------------	------------------------------

#### Dimming data

Input signal:	WiFi + RF 2.4GHz
Control distance:	30m (Barrier-free space)
Dimming gray scale:	4096 (2 <sup>12</sup> ) levels
Dimming range:	0 -100%
Dimming curve:	Logarithmic
PWM frequency:	1000Hz (default)

#### Package

Dimensions (W x H x L):	1.49" x 0.78" x 4.48"
Gross weight:	0.073kg

#### Safety and EMC

EMC standard:	EN IEC 55015/EN IEC 61547 ETSI EN 301 489-1/-3/-17
Safety standard:	EN 61347-1/-2
Radio Equipment:	ETSI EN 300 440 ETSI EN 300 328
Certification:	FCC UL CE RoHS

#### Warranty and Protection

Warranty:	5 years
Protection:	Reverse polarity Over-heat Short circuit